

The following symbols in the Operating Instructions indicate safety precautions which must be strictly observed:

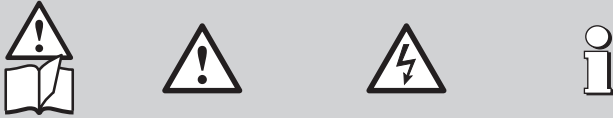

The instruments must only be disposed of in the correct way!

## Operating Instructions

## Passive DC signal isolator SINEAX TI 807-5



Camille Bauer LTD  
Aargauerstrasse 7  
CH-5610 Wohlen/Switzerland  
Phone +41 56 618 21 11  
Fax +41 56 618 35 35  
info@camillebauer.com  
www.camillebauer.com



TI 807-5 Be 999766-03 03.11

## Contents

1. Read first and then ...	1
2. Scope of supply	1
3. Brief description	1
4. Specification and ordering information	1
5. Technical data	1
6. Mounting	2
7. Electrical connections	3
8. Commissioning and maintenance	3
9. Releasing the signal isolator	3
10. Dimensional drawings	4
11. Declaration of conformity	4

### 1. Read first and then ...



The proper and safe operation of the device assumes that the Operating Instructions are **read carefully** and the safety warnings given in the sections

#### 6. Mounting

#### 7. Electrical connections

are **observed**.

The device should only be handled by appropriately trained personnel who are familiar with it and authorised to work in electrical installations.

Unauthorized repair or alteration of the unit invalidates the warranty!

### 2. Scope of supply

Signal isolator (Fig. 1)

1 Adapter (Fig. 1) for wall mounting

1 copy Operating Instructions (Fig. 2) in English, French, German

1 Ex approval (Fig. 2), only for Ex version devices



Fig. 1



Fig. 2

### 3. Brief description

The signal isolator SINEAX TI 807 serves to electrically insulate one analogue DC signal in the range 0...20 mA which depending on version is then converted to a current or voltage signal (0...20 mA or 0...10 V). It does **not** require a separate power supply.

### 4. Specification and ordering information

Order Code 807 –	5	1		
<b>1. Mechanical design</b>	↑	↑	↑	↑
Housing N17	5			
<b>2. Version</b>		↑	↑	↑
Standard (non-Ex)		1		
Input and output signals				
<b>non-intrinsically safe</b>				
[EEx ib] IIC			2	
Input signal <b>intrinsically safe</b>				
[EEx ia] IIC			6	
Output signal <b>intrinsically safe</b>				
<b>3. Number of isolation and transmission channels</b>				↑
1 channel (interface)				1
<b>4. Output signal A</b> $\rightarrow$				↑
0 ... 20 mA				0
0 ... 10 V				1
<b>5. Climatic rating</b>				↑
Standard climatic rating				0
Improved climatic rating				1

### 5. Technical data

#### Input signal E $\rightarrow$

DC current signal  $I_E$ : 0...20 mA

Max. permissible current: 50 mA

Voltage limiter: Non-Ex version: 27 V  $\pm$ 5%  
(with zener diode)

Ex version: 18 V  $\pm$ 5%

**Output signal A**  $\rightarrow$ 

(DC current or DC voltage)

**DC current signal  $I_A$ :** 0...20 mAVoltage drop  $U_V$ :

< 2.8 V	for the standard (non-Ex) version
< 4.7 V	for Ex versions (input signal "intrinsically safe")
< 6.3 V	for Ex versions (output signal "intrinsically safe")

Max. burden:

1000 $\Omega$	for the standard (non-Ex) version
500 $\Omega$	for Ex versions (input signal "intrinsically safe")
500 $\Omega$	for Ex versions (output signal "intrinsically safe")

Limit: Approx. 40 mA

Residual ripple: &lt;20 mV ss

Time constant: Approx. 3 ms

Response time<sup>1</sup>  
acc. to IEC 770: Approx. 15 ms**DC voltage signal  $U_A$ :** 0...10 VVoltage drop  $U_V$ :

< 2.8 V	for the standard (non-Ex) version
< 4.7 V	for Ex versions (input signal "intrinsically safe")
< 6.3 V	for Ex versions (output signal "intrinsically safe")

Internal resistance: 500  $\Omega$ 

Limit:

< 26 V	for the standard (non-Ex) version
< 16 V	for Ex versions (input signal "intrinsically safe")
< 16 V	for Ex versions (output signal "intrinsically safe")

Residual ripple: &lt; 20 mV ss

Time constant: Approx. 3 ms

Response time<sup>1</sup>  
acc. to IEC 770: Approx. 15 ms**Accuracy data**

Error limits: <  $\pm 0.1\%$ <sup>2</sup>  
(Reference value 20 mA including linearity error)  
<  $\pm 0.2\%$ <sup>3</sup>  
(Reference value 10 V including linearity error)

**Ambient conditions**

Operating temperature: -25 to +55 °C  
**-20 to +55 °C**  
(Ex versions: input or output signal "intrinsically safe")

Storage temperature: -40 to +70 °C

Annual mean relative humidity:  $\leq 75\%$  standard climatic rating  
 $\leq 95\%$  improved climatic rating

Seismic test: 5 g, &lt;200 Hz, 2 h in each of 3 directions

Shock: **50 g**, 10 shocks in each of 3 directions

Altitude: 2000 m max.

Indoor use statement!

<sup>1</sup> This is the time which transpires before the output signal reaches the error limit of 1% for a step change of the input signal from 0  $\rightarrow$  90%.

<sup>2</sup> With current signal and  $R_A = 250 \Omega$

<sup>3</sup> With voltage signal

**6. Mounting**

The SINEAX TI 807 can be mounted either on a top-hat rail or directly onto a wall or mounting plate using the adapter (standard accessory).



Make sure that the ambient temperature stays within the **permissible limits**:  
-25 and +55 °C for standard instruments  
**-20** and +55 °C for instruments in **Ex** version!

**6.1 Top-hat rail mounting**

Simply clip the device onto the top-hat rail (EN 50 022) (see Fig. 3).

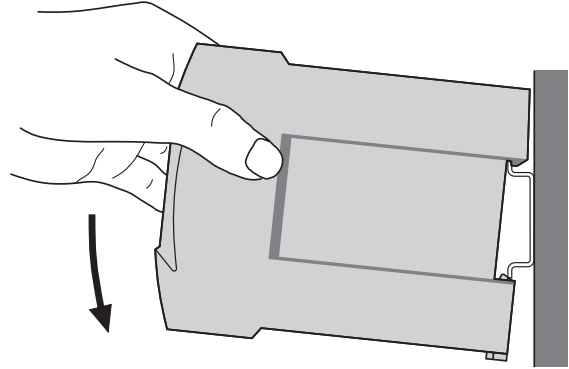

Fig. 3. Mounting on top-hat rails 35 x 15 or 35 x 7.5 mm.

**6.2 Wall mounting**

Drill 2 holes in the wall or panel as shown in the drilling pattern (Fig. 4). Now secure the adapter (standard accessory) to the wall or panel using two 5 mm diameter screws (Fig. 5). Clip the device onto the adapter (Fig. 6).

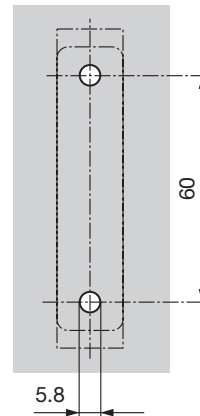

Fig. 4. Drilling pattern.

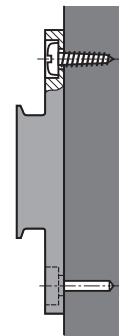

Fig. 5. Adapter mounted on wall.

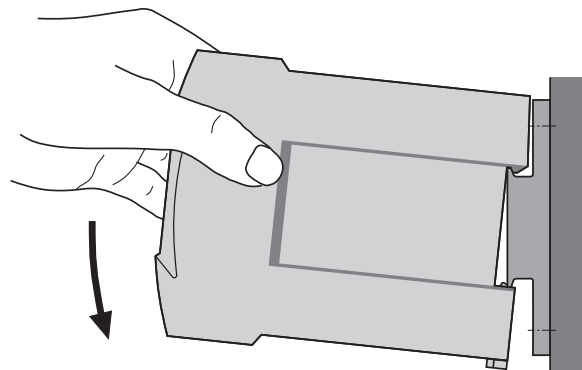

Fig. 6. Mounting on the adapter.

## 7. Electrical connections

The electrical connections are made to screw terminals which are easily accessible from the front of the signal isolator (see Fig. 8 and 9) and can accommodate wire gauges up to 2.5 mm<sup>2</sup>.



Make sure that the cables are not live when making the connections!



In the case of "Intrinsically safe" [EEx ib] IIC or [EEx ia] IIC explosionproof versions, the supplementary information given on the type examination certification, the EN 60 079-14 and also local regulations applicable to electrical installations in explosion hazard areas must be taken into account.



Note that, ...

... the required electrical insulation and transmission data agree with the data on the nameplate of the SINEAX TI 807 (→ input signal and → output signal, see Fig. 7)!

... in the case of a signal isolator with current outputs 0...20 mA, the total resistance of the external leads (receiver plus leads) does not exceed the maximum burden of 1000 Ω (non-Ex version) or 500 Ω (Ex version)! See "Output signal" in Section 5 "Technical data"!

... in the case of a signal isolator with voltage output 0...10 V, the external receiver connected across the output has a sufficiently high internal resistance  $R_{iA}$  in relation to the SINEAX TI 807 output impedance of 500 Ω! See "Output signal" in Section 5 "Technical data"!

The error due to  $R_{iA}$  is:

$$F [\%] = \frac{500 [\Omega] \cdot 100}{R_{iA} [\Omega]}$$

... the input and output cables should be twisted pairs and run as far as possible away from heavy current cables!

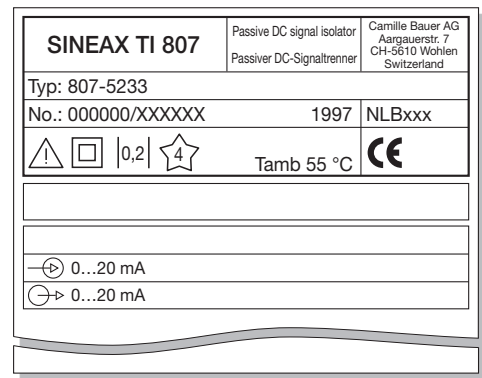

Fig. 7. Example of a nameplate.

Connect the input E and output A leads according to Figures 8 and 9.

### Signal isolator in housing N17 with one isolation and transmission channel

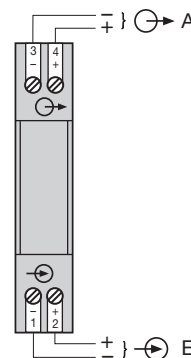

Fig. 8. SINEAX TI 807-511... Standard (non-Ex) version and SINEAX TI 807-561.. and TI 807-581... Ex version (output signal A "intrinsically safe")

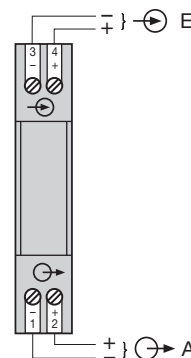

Fig. 9. SINEAX TI 807-521.. and TI 807-541... Ex version (input signal E "intrinsically safe")

## 8. Commissioning and maintenance

The device is in operation as soon as the input signal E is connected. The signal isolator requires no maintenance.

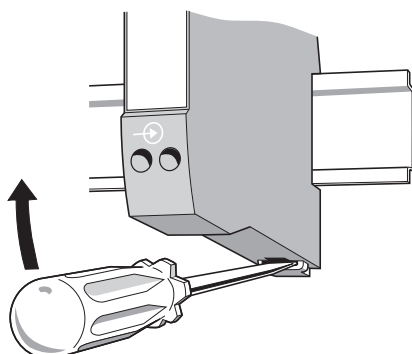

Fig. 10

## 9. Releasing the signal isolator

Release the signal isolator from a top-hat rail as shown in Fig. 10 or from the adapter as shown in Fig. 11.

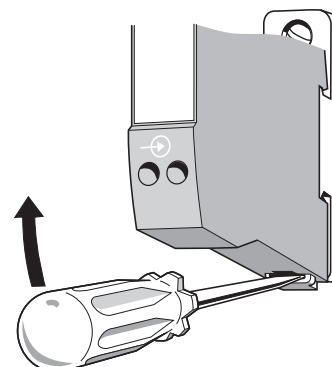

Fig. 11

## 10. Dimensional drawings

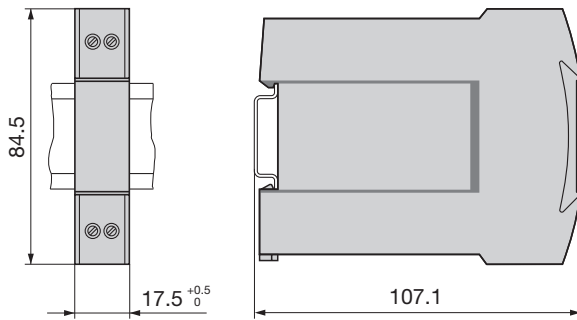

Fig. 12. SINEAX TI 807-5.... (housing N17) clipped onto a top-hat rail (35 x 7.5 or 35 x 15 mm, acc. to EN 50022).

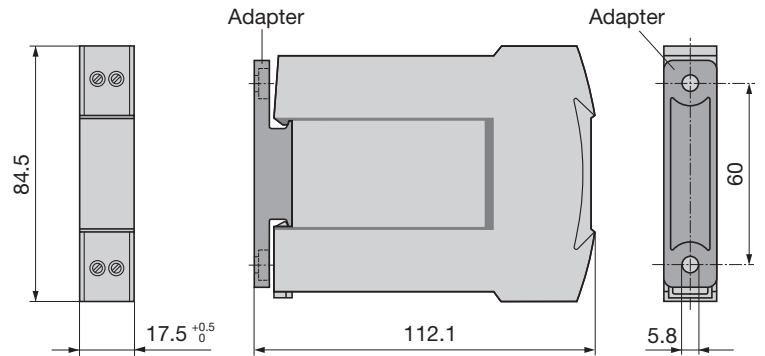

Fig. 13. SINEAX TI 807-5.... (housing N17) with adapter for wall mounting.

## 11. Declaration of conformity

**CE** EG - KONFORMITÄTSERKLÄRUNG **CAMILLE BAUER**  
DECLARATION OF CONFORMITY

Dokument-Nr./ Document.No.: TI807\_CE-konf.DOC

Hersteller/ Manufacturer: **Camille Bauer AG**  
Switzerland

Anschrift / Address: **Aargauerstrasse 7**  
**CH-5610 Wohlen**

Produktbezeichnung/ Product name: **Passiver DC-Signaltrenner ohne Hilfsenergie- Anschluss**  
Passive DC signal isolator without power supply

Typ / Type: **SINEAX TI 807**

Das bezeichnete Produkt stimmt mit den Vorschriften folgender Europäischer Richtlinien überein, nachgewiesen durch die Einhaltung folgender Normen:  
The above mentioned product has been manufactured according to the regulations of the following European directives proven through compliance with the following standards:

Nr. / No.	Richtlinie / Directive
2004/108/EG 2004/108/EC	Elektromagnetische Verträglichkeit - EMV - Richtlinie Electromagnetic compatibility -EMC directive

EMV / EMC	Fachgrundnorm / Generic Standard	Messverfahren / Measurement methods
Störaussendung / Emission	EN 61000-6-4 : 2007	EN 55011 : 2007+A2:2007
Störfestigkeit / Immunity	EN 61000-6-2 : 2005	IEC 61000-4-2: 1995+A1:1998+A2:2001 IEC 61000-4-3: 2006+A1:2007 IEC 61000-4-4: 2004 IEC 61000-4-6: 2008

Nr. / No.	Richtlinie / Directive
2006/95/EG	Elektrische Betriebsmittel zur Verwendung innerhalb bestimmter Spannungsgrenzen – Niederspannungsrichtlinie – CE-Kennzeichnung : 95
2006/95/EC	Electrical equipment for use within certain voltage limits – Low Voltage Directive – Attachment of CE mark : 95

EN/Norm/Standard	IEC/Norm/Standard
EN 61 010-1 : 2001	IEC 1010-1 : 2001

Die explosionsgeschützte Ausführung dieses Produkts stimmt mit der Europäischen Richtlinie 94/9/EG überein.  
The explosion protected variant of this product has been manufactured according to the European directive 94/9.

Ort, Datum / Place, date: Wohlen, 2. Oktober. 2009

Unterschrift / signature:  
*M. Ulrich* *J. Brem*

M. Ulrich Leiter Technik / Head of engineering  
J. Brem Qualitätsmanager / Quality manager

**CE** EG - KONFORMITÄTSERKLÄRUNG **CAMILLE BAUER**  
DECLARATION OF CONFORMITY

Dokument-Nr./ Document.No.: TI807EX\_CE-konf.DOC

Hersteller/ Manufacturer: **Camille Bauer AG**  
Switzerland

Anschrift / Address: **Aargauerstrasse 7**  
**CH-5610 Wohlen**

Produktbezeichnung/ Product name: **Passiver DC-Signaltrenner ohne Hilfsenergie- Anschluss**  
Passive DC signal isolator without power supply

Typ / Type: **SINEAX TI 807 EX**

Das bezeichnete Produkt stimmt mit den Vorschriften folgender Europäischer Richtlinien überein, nachgewiesen durch die Einhaltung folgender Normen:  
The above mentioned product has been manufactured according to the regulations of the following European directives proven through compliance with the following standards:

Nr. / No.	Richtlinie / Directive
2004/108/EG 2004/108/EC	Elektromagnetische Verträglichkeit - EMV - Richtlinie Electromagnetic compatibility -EMC directive

EMV / EMC	Fachgrundnorm / Generic Standard	Messverfahren / Measurement methods
Störaussendung / Emission	EN 61000-6-4 : 2007	EN 55011 : 2007+A2:2007
Störfestigkeit / Immunity	EN 61000-6-2 : 2005	IEC 61000-4-2: 1995+A1:1998+A2:2001 IEC 61000-4-3: 2006+A1:2007 IEC 61000-4-4: 2004 IEC 61000-4-6: 2008

Nr. / No.	Richtlinie / Directive
2006/95/EG	Elektrische Betriebsmittel zur Verwendung innerhalb bestimmter Spannungsgrenzen – Niederspannungsrichtlinie – CE-Kennzeichnung : 95
2006/95/EC	Electrical equipment for use within certain voltage limits – Low Voltage Directive – Attachment of CE mark : 95

EN/Norm/Standard	IEC/Norm/Standard
EN 61 010-1 : 2001	IEC 1010-1 : 2001

Die explosionsgeschützte Ausführung dieses Produkts stimmt mit der Europäischen Richtlinie 94/9/EG überein.  
The explosion protected variant of this product has been manufactured according to the European directive 94/9.

Ort, Datum / Place, date: Wohlen, 2. Oktober. 2009

Unterschrift / signature:  
*M. Ulrich* *J. Brem*

M. Ulrich Leiter Technik / Head of engineering  
J. Brem Qualitätsmanager / Quality manager